

DATE
MAY 11. 2015
CATALOG NO.
XPV0022C

OUTLINE DIMENSIONS
3-PHASE INDUCTION MOTOR

MOTOR TYPE:
AEUHXG
FRAME NO. 145TC

Pole	HP	KW	Hz	VOLT	Syn. Speed RPM
2	2	1.5	60	230/460	3600

Ins	Rating	Dimension in	Approx Weight	Bearings
F	CONT.	inches	75 lbs.	DE: 6205ZZ NDE: 6205ZZ

Totally Enclosed Fan-Cooled Type. Squirrel-Cage Rotor.

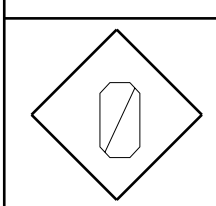
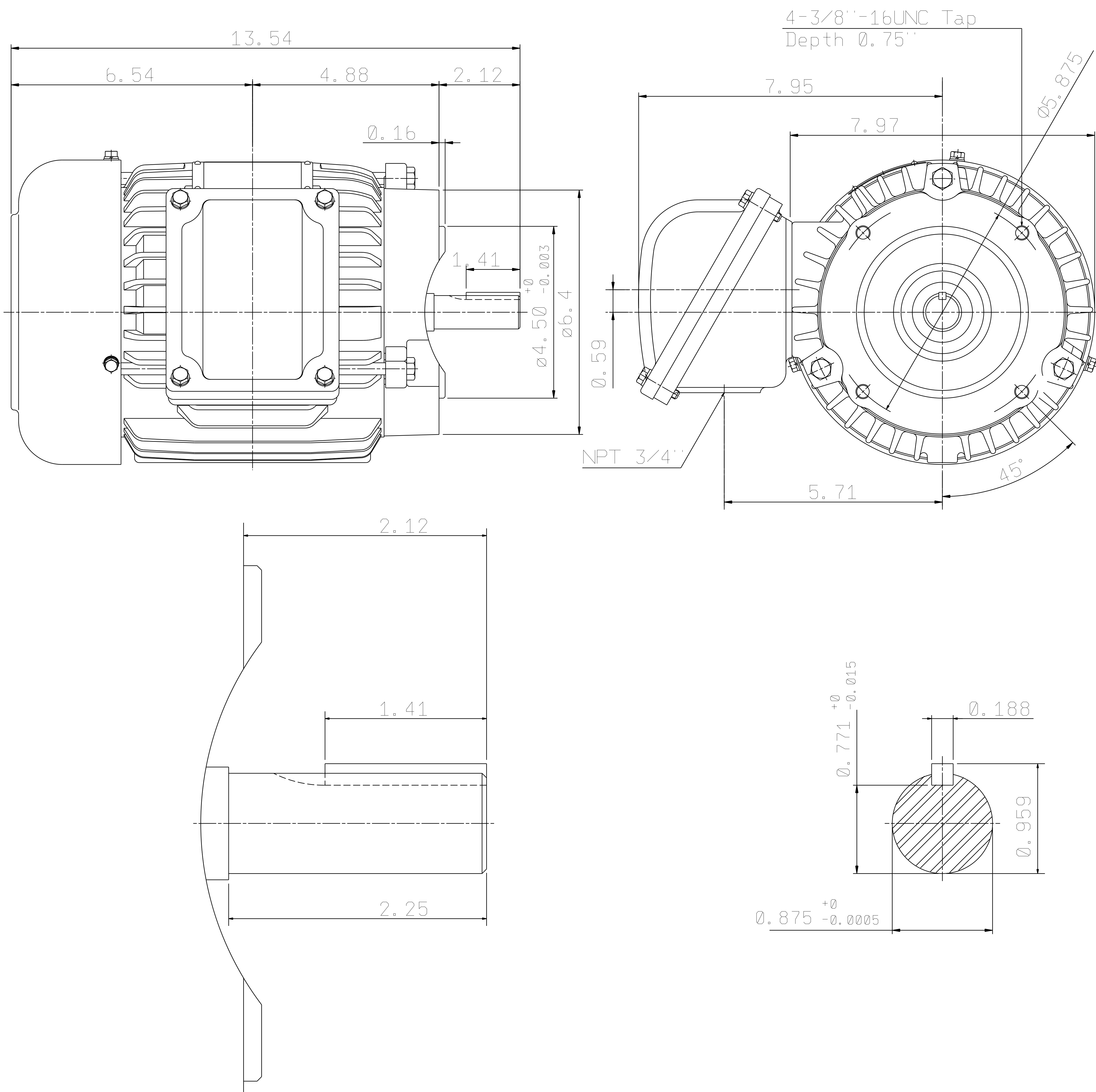

DWN.	J.H. LIANG	11-12-98
CHKD.	C.S. LO	11-23-98
APPD.	Y.B. HUANG	11-23-98



DWG NO.